



Installation Instructions

Introduction:

Having received your order, we strongly recommend storing the products and allowing to climatise for 24 hours prior to installation and only undertaken when the external temperature is greater than 3 Degrees Celsius.

Composite decking should always be laid on a supporting structure and never directly onto the ground. We recommend using our own Joists due to their life expectancy; however, timber can also be used.

Tools Required:

Level, Saw, Drill & Screwdriver

Personal Protection Equipment:

Please ensure safety precautions are followed and recommend the use of protective clothing, gloves, safety goggles and dust mask.

Stage 1: Substrate

Ensure the substrate is flat and suitable. The base should be solid and sturdy (ideally concrete) and have a slight slope to allow for water run off which should always run away from the property. Typically, we suggest a gradient of 1:100 / 10mm for every metre.

Stage 2: Supporting Structure

The Installation of joists will all depend on your personal design, however we recommend spacing at 300mm centres with an absolute maximum of 400mm centres. Consideration should be given to design as any butt joints in the decking itself will require an additional supporting joist due to each board requiring its own 3mm or 6mm spacer.

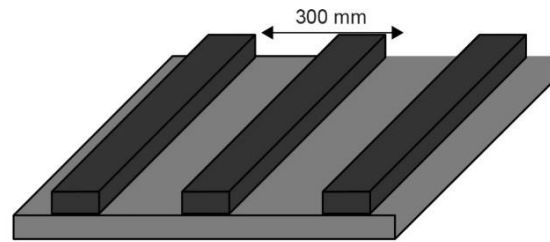

Stage 3:

We strongly recommend a minimum 10mm gap is left between the joists and any fixed object (house, outbuilding etc) and 6mm where 2 joists are butt jointed together. This allows for contraction and expansion during temperature change.

Stage 4: Main Decking

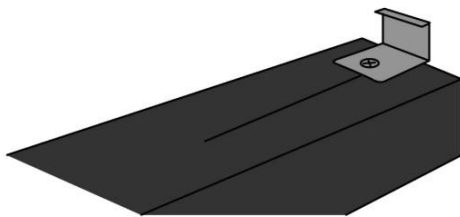

Install a Starter Clip where you wish to start Installation. Again, this should follow the 10mm principle mentioned in Stage 3. We recommend pre-drilling holes to ensure no damage to the joist.

Stage 5:

Continue the Starter Clip installation all the way along from start to finish. These should follow the joist installation which should be at the recommended 300mm centres.

Stage 6:

Cut the first decking board to length and slide into the installed Starter Clips.

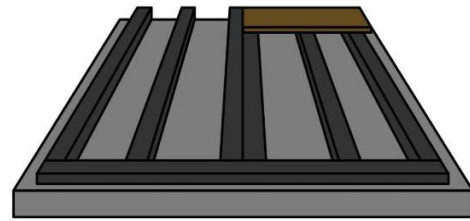

Stage 7:

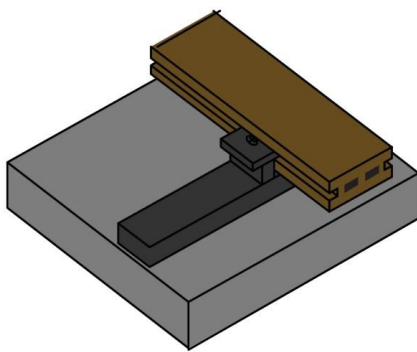

With the first decking board in place, secure on the opposite side to starter clip using either 3mm or 6mm spacers. Again, these should be installed at every joist, pre-drilling holes to ensure no damage to joist.

Stage 8:

Install the next decking board by sliding into the previous row of 3mm or 6mm spacers and continue the process described in Stage 7 until the last but one decking board.

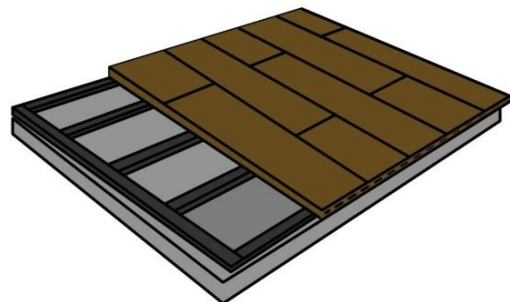

Stage 9:

Should you have any butt joints where 2 lengths of decking meet, we recommend a supporting joist for each as each board will require its own 3mm or 6mm spacer (as detailed in stage 2).

Stage 10:



It's now time to install the final two decking boards. First, install the very last decking board in the sequence by repeating the instructions given in stages 4, 5 & 6.

Stage 11:

To secure the final decking board (which is the last but one board), first slide the decking board into the row of 3mm or 6mm spacers already installed and then simply slide either the 3mm or 6mm spacers between the gap of the final two decking boards, align with the joists and secure as previous.

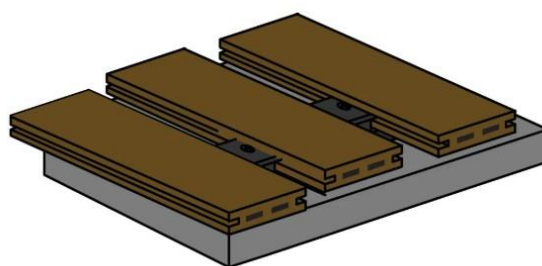

Stage 12: Accessories

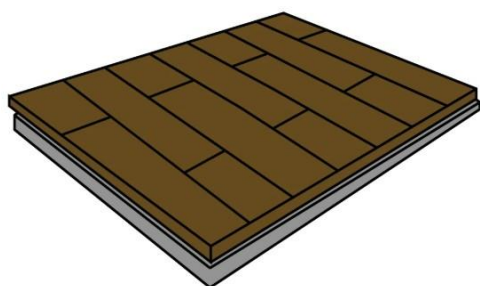

To complete your installation, use the fascia board's and corner trim's. These should be cut to size and installed with a suitable adhesive. We do not recommend the use of mechanical fixings. When using the fascia board, we recommended leaving a 6mm gap between the actual decking boards themselves and the fascia board to allow for contraction and expansion during temperature change.

These Installation Instructions are given as a guide only and we do not accept any liability for any loss or injury caused by the information detailed within.

If you require any further assistance, please do not hesitate to contact our friendly team on 0118 324 8040 or e-mail support@thedecking.store - We're here to help!